

MILL 047" SURFACE

PROJECT PROJÉT
SPEC TYPE
NOTES



SHADE FINISH FINI ABAT-JOUR



ADDITIONAL PREMIUM COLORS AVAILABLE – SEE ACOUSTIC MATERIAL COLOR OPTIONS PAGE

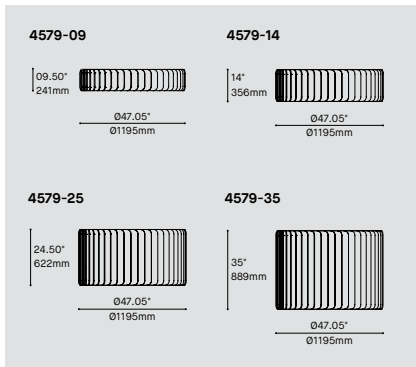

ORDERING SPECIFICATION SPÉCIFICATION DE COMMANDE

CODE

MODEL MODÈLE

4579-09	MILL 9.5"
4579-14	MILL 14"
4579-25	MILL 25"
4579-35	MILL 35"

LIGHT SOURCE SOURCE LUMINEUSE

LED.LO	LOW OUTPUT
LED	REGULAR OUTPUT
LED.HO	HIGH OUTPUT

COLOR TEMPERATURE TEMPÉRATURE DE COULEUR

27*	2700K
30	3000K
35	3500K
40	4000K

* LONGER LEAD TIME MAY APPLY, PLEASE CONTACT YOUR EUREKA REPRESENTATIVE

COLOR RENDERING INDEX (CRI) INDICE DE RENDU DE COULEUR (IRC)

90	90+ CRI	90
----	---------	----

VOLTAGE VOLTAGE

120V	120 VOLT
277V	277 VOLT

CONTROL OPTION OPTION DE CONTRÔLE

DV	0-10V DIMMING (120V-277V)
NLTAIR2*	NLIGHT AIR CONTROL GEN 2
NLIGHT*	NLIGHT WIRED CONTROL

* NLIGHT INTEGRATION REQUIRES A REMOTE POWER PACK (39NLAB FOR NLTAIR2 OR 39NLWB FOR NLIGHT).
 * DUAL DIMMING NOT AVAILABLE WITH NLIGHT OPTIONS
 * FOR EMERGENCY BATTERY WITH NLIGHT OPTIONS, PLEASE CONTACT YOUR EUREKA REPRESENTATIVE
 REFER TO NLIGHT GUIDE AND INSTALLATION SHEET FOR ALL REQUIREMENTS.

EMERGENCY BATTERY BATTERIE D'URGENCE

EM DRIVER BOX INCLUDED, INSTALLED REMOTELY. SEE EM GUIDE FOR DETAILS.

EMB*	EMERGENCY BATTERY FOR REMOTE BOX
	* 3981EA ACCESSORY IS REQUIRED

SHADE FINISH FINI ABAT-JOUR

ABF	AZURE BLUE FELT	BYF	BANANA YELLOW FELT	REF	RED FELT
AWF	ARCTIC WHITE FELT	CHF	CHARCOAL FELT	SGF	SILVER GRAY FELT
BBF	BASIC BLACK FELT	NBF	NAVY BLUE FELT	TGF	TITANIUM GRAY FELT
BOF	BLOOD ORANGE FELT	OBF	OCEAN BLUE FELT	ZFF	ZINFANDEL FELT
BTF	BATTLESHIP GRAY FELT	PGF	PEAR GREEN FELT		
PREMIUM*	PLEASE SPECIFY PREMIUM COLOR CODE – SEE ACOUSTIC MATERIAL COLOR OPTIONS PAGE * LONGER LEAD TIME MAY APPLY, PLEASE CONTACT YOUR EUREKA REPRESENTATIVE				

DIFFUSER FINISH FINI DIFFUSEUR

WH	WHITE	WH
----	-------	----

ACCESSORY ACCESSOIRE

ALL ACCESSORIES ARE AVAILABLE FOR ADVANCE SHIPPING

39NLAA*	NLIGHT AIR GEN 2 REMOTE POWER PACK
39NLWA*	NLIGHT WIRED REMOTE POWER PACK
	* FOR CHICAGO PLENUM INSTALLATION, PLEASE CONTACT YOUR EUREKA REPRESENTATIVE.

EMERGENCY BATTERY ACCESSORY ACCESSOIRE BATTERIE D'URGENCE

3981EA	ELECTRICAL BOX FOR EMB EMERGENCY BATTERY
--------	--

PRODUCT CHARACTERISTICS CARACTÉRISTIQUES DU PRODUIT



DESIGN: MILL is a high-performance fixture with a simple shape punctuated by its repeated acoustic felt panels. With its four different diameters, four different lengths and two mounting options, this fixture is versatile to suite various needs and spaces.

INSTALLATION: Easy to install, adjust and level single aircraft cable mounting, with clip-on acoustic panels. Also available as surface mount.

LIGHT SOURCE: This pendant offers powerful and evenly diffused lighting with a COB light source. Phase or 0-10V dimming offered. MILL is also offered with an optional indirect light option on a secondary circuit allowing independent control.

SHADE: The custom CNC-cut rigid felt acoustic panels are available in multiple colors. Composed mainly of recycled polyethylene (PET) bottles which make them recyclable and odorless.

MILL 047" SURFACE

PROJECT PROJET
SPEC TYPE
NOTES



SHADE FINISH FINI ABAT-JOUR



ADDITIONAL PREMIUM COLORS AVAILABLE – SEE ACOUSTIC MATERIAL COLOR OPTIONS PAGE

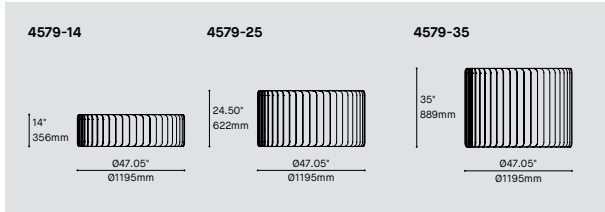

ORDERING SPECIFICATION SPÉCIFICATION DE COMMANDE

CODE

MODEL MODÈLE	
4579-14	MILL 14"
4579-25	MILL 25"
4579-35	MILL 35"
LIGHT SOURCE SOURCE LUMINEUSE	
LED.LO	LOW OUTPUT
LED	REGULAR OUTPUT
LED.HO	HIGH OUTPUT
COLOR TEMPERATURE TEMPÉRATURE DE COULEUR	
27*	2700K
30	3000K
35	3500K
40	4000K
* LONGER LEAD TIME MAY APPLY, PLEASE CONTACT YOUR EUREKA REPRESENTATIVE	

COLOR RENDERING INDEX (CRI) INDICE DE RENDU DE COULEUR (IRC)		90
90	90+ CRI	

VOLTAGE VOLTAGE	
120V	120 VOLT
277V	277 VOLT

CONTROL OPTION OPTION DE CONTRÔLE	
DV	0-10V DIMMING (120V-277V)
NLTAIR2*	NLIGHT AIR CONTROL GEN 2
NLIGHT*	NLIGHT WIRED CONTROL
*NLIGHT INTEGRATION REQUIRES A REMOTE POWER PACK (39NLAB FOR NLTAIR2 OR 39NLWB FOR NLIGHT).	
* DUAL DIMMING NOT AVAILABLE WITH NLIGHT OPTIONS	
* FOR EMERGENCY BATTERY WITH NLIGHT OPTIONS, PLEASE CONTACT YOUR EUREKA REPRESENTATIVE REFER TO NLIGHT GUIDE AND INSTALLATION SHEET FOR ALL REQUIREMENTS.	

EMERGENCY BATTERY BATTERIE D'URGENCE	
EM DRIVER BOX INCLUDED, INSTALLED REMOTELY. SEE EM GUIDE FOR DETAILS.	
EMB*	EMERGENCY BATTERY FOR REMOTE BOX
* 3981EA ACCESSORY IS REQUIRED	

SHADE FINISH FINI ABAT-JOUR					
ABF	AZURE BLUE FELT	BYF	BANANA YELLOW FELT	REF	RED FELT
AWF	ARCTIC WHITE FELT	CHF	CHARCOAL FELT	SGF	SILVER GRAY FELT
BBF	BASIC BLACK FELT	NBF	NAVY BLUE FELT	TGF	TITANIUM GRAY FELT
BOF	BLOOD ORANGE FELT	OBF	OCEAN BLUE FELT	ZFF	ZINFANDEL FELT
BTF	BATTLESHIP GRAY FELT	PGF	PEAR GREEN FELT		
PREMIUM*	PLEASE SPECIFY PREMIUM COLOR CODE – SEE ACOUSTIC MATERIAL COLOR OPTIONS PAGE				
* LONGER LEAD TIME MAY APPLY, PLEASE CONTACT YOUR EUREKA REPRESENTATIVE					

DIFFUSER FINISH FINI DIFFUSEUR		WH
WH	WHITE	

ACCESSORY ACCESSOIRE	
ALL ACCESSORIES ARE AVAILABLE FOR ADVANCE SHIPPING	
39NLAA*	NLIGHT AIR GEN 2 REMOTE POWER PACK
39NLWA*	NLIGHT WIRED REMOTE POWER PACK
* FOR CHICAGO PLENUM INSTALLATION, PLEASE CONTACT YOUR EUREKA REPRESENTATIVE.	

EMERGENCY BATTERY ACCESSORY ACCESSOIRE BATTERIE D'URGENCE	
3981EA	ELECTRICAL BOX FOR EMB EMERGENCY BATTERY

PRODUCT CHARACTERISTICS CARACTÉRISTIQUES DU PRODUIT



- DESIGN:** MILL is a high-performance fixture with a simple shape punctuated by its repeated acoustic felt panels. With its three different diameters, three different lengths and two mounting options, this fixture is versatile to suite various needs and spaces.
- INSTALLATION:** Easy to install, adjust and level single aircraft cable mounting, with clip-on acoustic panels. Also available as surface mount.
- LIGHT SOURCE:** This pendant offers powerful and evenly diffused lighting with a COB light source. Phase or 0-10V dimming offered. MILL is also offered with an optional indirect light option on a secondary circuit allowing independent control.
- SHADE:** The custom CNC-cut rigid felt acoustic panels are available in multiple colors. Composed mainly of recycled polyethylene (PET) bottles which make them recyclable and odorless.

MILL 047" SURFACE

QUICKSHIP

PROJECT PROJET

SPEC TYPE

NOTES



SHADE FINISH FINI ABAT-JOUR

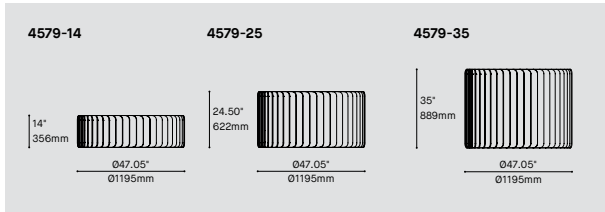

ORDERING SPECIFICATION SPÉCIFICATION DE COMMANDE

CODE

QUICKSHIP

QS10 QUICKSHIP 10 DAYS - MAXIMUM 5 UNITS QUICKSHIP 10 JOURS - MAXIMUM 5 UNITÉS

MODEL MODÈLE

4579-14 MILL 14"
4579-25 MILL 25"
4579-35 MILL 35"

LIGHT SOURCE SOURCE LUMINEUSE

LED.LO LOW OUTPUT
LED REGULAR OUTPUT
LED.HO HIGH OUTPUT

COLOR TEMPERATURE TEMPÉRATURE DE COULEUR

30 3000K
35 3500K

COLOR RENDERING INDEX (CRI) INDICE DE RENDU DE COULEUR (IRC)

90 90+ CRI

90

VOLTAGE VOLTAGE

120V 120 VOLT
277V 277 VOLT

CONTROL OPTION OPTION DE CONTRÔLE

DV 0-10V DIMMING (120V-277V)

DV

SHADE FINISH FINI ABAT-JOUR

ABF	AZURE BLUE FELT	BYF	BANANA YELLOW FELT	REF	RED FELT
AWF	ARCTIC WHITE FELT	CHF	CHARCOAL FELT	SGF	SILVER GRAY FELT
BBF	BASIC BLACK FELT	NBF	NAVY BLUE FELT	TGF	TITANIUM GRAY FELT
BOF	BLOOD ORANGE FELT	OBF	OCEAN BLUE FELT	ZFF	ZINFANDEL FELT
BTF	BATTLESHIP GRAY FELT	PGF	PEAR GREEN FELT		

DIFFUSER FINISH FINI DIFFUSEUR

WH WHITE

WH

PRODUCT CHARACTERISTICS CARACTÉRISTIQUES DU PRODUIT



DESIGN:

MILL is a high-performance fixture with a simple shape punctuated by its repeated acoustic felt panels. With its three different diameters, three different lengths and two mounting options, this fixture is versatile to suite various needs and spaces.

INSTALLATION:

Easy to install, adjust and level single aircraft cable mounting, with clip-on acoustic panels. Also available as surface mount.

LIGHT SOURCE:

This pendant offers powerful and evenly diffused lighting with a COB light source. Phase or 0-10V dimming offered. MILL is also offered with an optional indirect light option on a secondary circuit allowing independent control.

SHADE:

The custom CNC-cut rigid felt acoustic panels are available in multiple colors. Composed mainly of recycled polyethylene (PET) bottles which make them recyclable and odorless.

Acoustic Material Color Options for Mill



Standard colors



ABF
Azure Blue

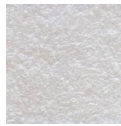

AWF
Arctic White

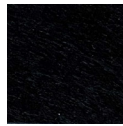

BBF
Basic Black



BOF
Blood Orange

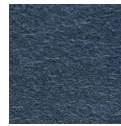

BTF
Battleship Gray



BYF
Banana Yellow



CHF
Charcoal

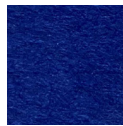

NBF
Navy Blue

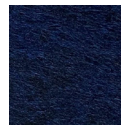

OBF
Ocean Blue

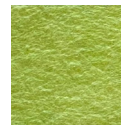

PGF
Pear Green



REF
Red



SGF
Silver Gray



TGF
Titanium Gray

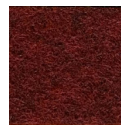

ZFF
Zinfandel

Premium colors



BGF
Bubble Gum



BKF
Bark Brown



DBF
Denim Blue

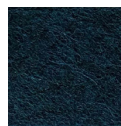

DTF
Deep Teal Green

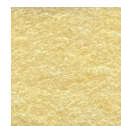

DYF
Daisy Yellow

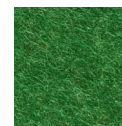

GGF
Grass Green



LBF
Light Beige

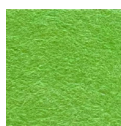

LGF
Lime Green

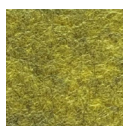

MGF
Moss Green

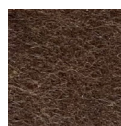

OAF
Oak Brown



PBF
Peanut Brown



PNF
Pinot Noir

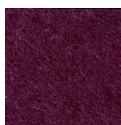

PPF
Plum Purple



SBF
Sky Blue



TOF
Tangerine Orange



TPF
Tulip Purple

- Premium colors carry extended lead times. Additional fees may apply for expedited lead times. Please consult factory.
- Due to the dye process, colors may vary slightly from batch to batch.

MILL Ø36" / Ø47"

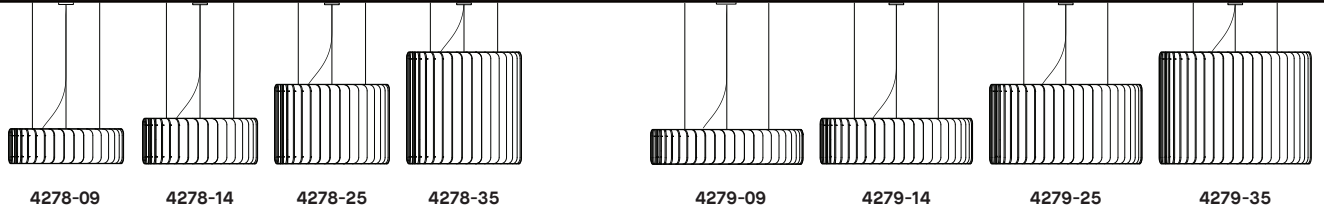

TWO MOUNTING OPTIONS
The fixture can be suspended or surface mounted depending of the space needs.

CANOPY POSITION

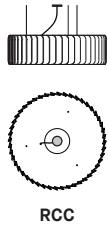

RECYCLED PANELS

Custom CNC cut panels composed of polyester fibers (PET) with 42% recycled content. 100% recyclable, non-toxic, non-allergenic and non-irritable. The material is also low VOC and fire rated.



FLEXIBLE ENGINES

LOW, REG and HIGH output light engine allows for a wide range of applications.



NOISE REDUCTION

The arrangement of the vertical panels increases the effective surface area of sound absorbing material optimizing the acoustic performance of the luminaire. The panels are available in 30 colors. For all color options, refer to the Acoustic Material Color Options page.

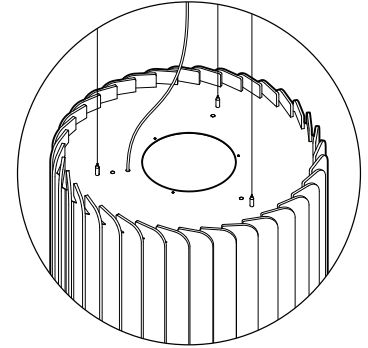

427X-DI

TRUE UPLIGHT

The suspended version offers an optional second light source with great uplight performance. Both light sources can be dimmed separately. We recommend a minimum suspension of 22" for a diffused uplight.

CLEANING

A proper and regular cleaning will help extend the lifespan of acoustic products. Periodic cleaning can be done with a vacuum or wiping with a damp microfiber cloth. Do not use any abrasive, soap, or chemical cleaner.

PRODUCT SPECIFICATION	Ø36" DIRECT			Ø47" DIRECT			Ø36"/ Ø47" INDIRECT	
	LO	REG	HO	LO	REG	HO	REG	HO
PERFORMANCE								
SYSTEM WATTAGE	56W	82W	121W	128W	185W	276W	19W	29W
DELIVERED LUMENS (4000K)	3955 LM	5390 LM	7424 LM	8784 LM	11971 LM	16489 LM	1408 LM	2051 LM
OTHER INFORMATION								
WEIGHT	40LBS / 18KG			60LBS / 27KG				
L70 (LUMEN MAINTENANCE)	60,000			54,700				
WELL & LEED STANDARD REQUIREMENTS								
MAX. LUMINANCE 45°-90° OF NADIR	1 150 CD/M ² (AT HO)							
LIGHT QUALITY	R9 > 50 (WITH 4000K)							

EFFICACY MULTIPLIERS

CRI	CCT	FACTOR
90+	4000K	1.00
90+	3500K	0.98
90+	3000K	0.94
90+	2700K	0.91

LIGHT DISTRIBUTION

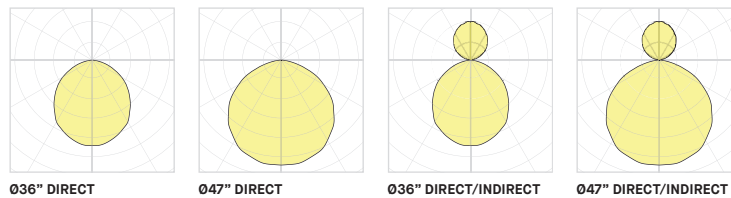

Visit our website for warranty terms and conditions.



TECHNICAL DATA

MILL 036" / 047"

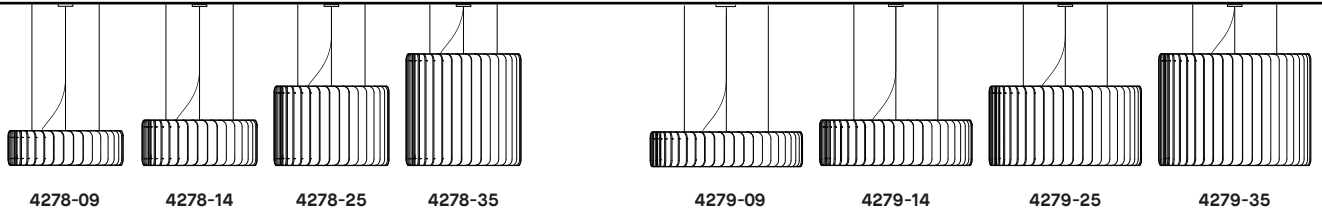

4278-09

4278-14

4278-25

4278-35

4279-09

4279-14

4279-25

4279-35



ATTÉNUATION DU BRUIT

La superposition des panneaux verticaux augmente la surface effective du matériel insonorisant, optimisant les performances acoustiques du luminaire. Les panneaux sont disponibles en 30 couleurs. Pour toutes options de couleurs, consulter la page d'options de couleurs de matérielle acoustique.

DEUX OPTIONS DE MONTAGE

Le luminaire peut être suspendu ou monté en surface selon les besoins de l'espace.

POSITION CANOPY

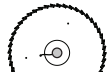
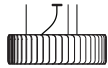

RCC

PANNEAUX RECYCLÉS

Panneaux composés de fibres de polyester (PET) avec 42% de matière recyclées. 100% recyclable, non-toxique, non-allergène et non-irritable. Faible teneur en COV et résistance au feu.



SOURCES POLYVALENTES

Source LOW, REG et HO permettent une grande variété d'applications.

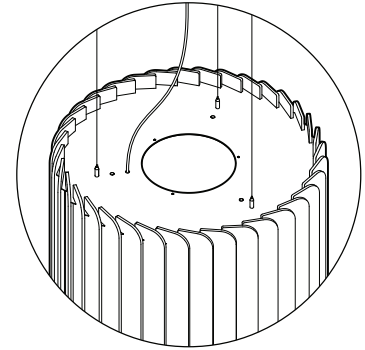

427X-DI

SOURCE INDIRECTE PUISSANTE

La version suspension offre en option une seconde source lumineuse pour offrir un éclairage indirect performant. Les deux sources peuvent se régler séparément. Nous recommandons une suspension minimum de 22" pour avoir une lumière indirecte diffuse.

NETTOYAGE

Un nettoyage approprié et régulier contribuera à prolonger la durée de vie des produits acoustiques. Un nettoyage périodique peut être fait avec un aspirateur ou en essuyant avec un chiffon humide. Ne pas utiliser de produits abrasifs, de savon ou de produits nettoyants chimiques.

SPÉCIFICATION PRODUIT

036" DIRECT

047" DIRECT

036"/047" INDIRECT

PERFORMANCE	LO	REG	HO	LO	REG	HO	REG	HO
PUISSANCE TOTALE	56W	82W	121W	128W	185W	276W	19W	29W
LUMENS RÉELS (4000K)	3955 LM	5390 LM	7424 LM	8784 LM	11971 LM	16489 LM	1408 LM	2051 LM
AUTRES INFORMATION								
POIDS	40LBS / 18KG			60LBS / 27KG				
L70 (MAINTENANCE DE LA LUMIÈRE)	60,000			54,700				
CRITÈRES DE CERTIFICATION WELL								
MAX. LUMINANCE 450-900 NADIR	1 150CD/M ² (EN HO)							
QUALITÉ DE LA LUMIÈRE	R9 > 50 (OPTION 90 IRC)							

FACTEUR D'EFFICACITÉ

IRC	CCT	FACTEUR
90+	4000K	1.00
90+	3500K	0.98
90+	3000K	0.94
90+	2700K	0.91

DISTRIBUTION LUMINEUSE

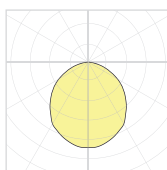

036" DIRECT

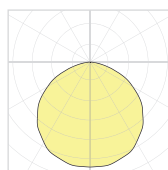

047" DIRECT

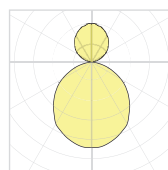

036" DIRECT/INDIRECT

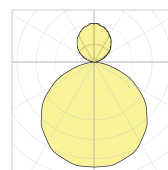

047" DIRECT/INDIRECT



Visitez notre site Web pour les termes et conditions.



DONNÉES TECHNIQUES